

MOFFAT 

*OPERATING & INSTALLATION
INSTRUCTIONS*

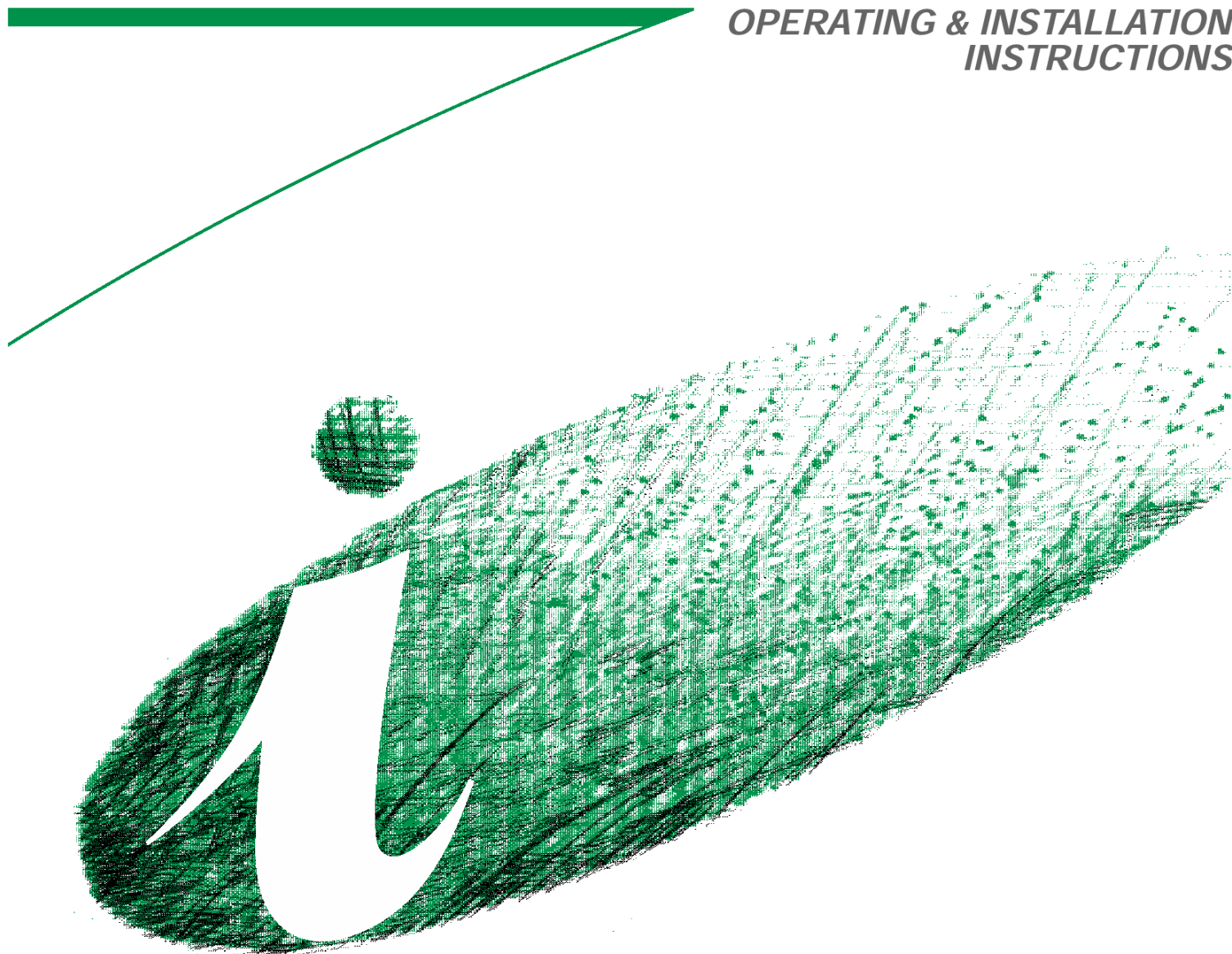

GAS COOKER
GSC 5062

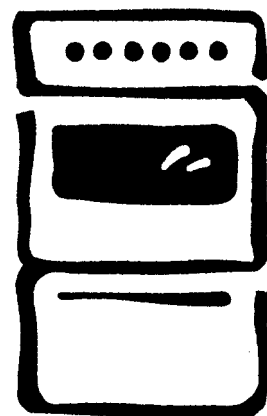

GB

CONTENTS

Instructions for the user		Instructions for the installer	
Important Safety Information	4	Safety Advice	18
Description of the appliance	5	Electric connection	18
Technical Features	6	Technical Data	19
Using the appliance	7	Installation	19
- Using the oven	7	- Positioning	19
- Hints & Tips	9	- Ventilation	20
- Using the Grill	10	- Location	20
- Using the Hob	11	Gas connections	21
Maintenance and Cleaning	13	Conversion of gas	22
Something Not Working	15		
Service & Spare Parts	16		
Customer Care	16		
Guarantee Conditions	17		

How to read the instruction book

The symbols below will guide you when reading the instruction book



Safety instructions



Step by Step Operation



Advice and recommendations



Environmental Information

IMPORTANT SAFETY INFORMATION



You MUST read these warnings carefully before installing or using the appliance. If you need assistance, contact our Customer Care Department on 08705 950950.

Installation

- This cooker must be installed by qualified personnel, according to the manufacturer's instructions and to the relevant British Standards.
- This cooker is heavy. Take care when moving it.
- Any gas installation must be carried out by a registered CORGI installer.
- Remove all packaging before using the cooker.
- Ensure that the gas and electrical supply complies with the type stated on the rating plate, located near the gas supply pipe.
- Do not attempt to modify the cooker in any way.

Child Safety

- This cooker is designed to be operated by adults. Do not allow children to play near or with the cooker.
- The cooker gets hot when it is in use. Children should be kept away until it has cooled.
- Children can also injure themselves by pulling pans or pots off the cooker.

During Use

- This cooker is intended for domestic cooking only. It is not designed for commercial or industrial purposes.
- When in use a gas cooker will produce heat and moisture in the room in which it has been installed. Ensure there is a continuous air supply, keeping air vents in good condition or installing a cooker hood with a venting hose.
- When using the cooker for a long period time, the ventilation should be improved, by opening a window or increasing the extractor speed.
- Do not use this cooker if it is in contact with water. Do not operate the cooker with wet hands.
- The grill pan will become hot during use, always use oven gloves when removing or replacing a hot grill pan.

- Ensure the control knobs are in the 'OFF' position when not in use.
- When using other electrical appliances, ensure the cable does not come into contact with the hot surfaces of the cooker.
- Unstable or misshapen pans should not be used on the hob burners as unstable pans can cause an accident by tipping or spillage.
- Never leave the cooker unattended when cooking with oil and fats.
- This cooker should be kept clean at all times. A build-up of fats or foodstuffs could result in a fire.
- Never use plastic dishes in the oven or on the hob burners. Never line any part of the oven with aluminium foil.
- Always ensure that the oven vent, which is located at the centre back of the hob, is left unobstructed to ensure ventilation of the oven cavity.
- Perishable food, plastic items and aerosols may be affected by heat and should not be stored above the cooker.

Service

- This cooker should only be repaired or serviced by an authorised Service Engineer and only genuine approved spare parts should be used.



Environmental Information

- After installation, please dispose of the packaging with due regard to safety and the environment.
- When disposing of an old appliance, make it unusable, by cutting off the cable.

Keep this instruction book for future reference and ensure it is passed on to any new owner.

DESCRIPTION OF THE APPLIANCE

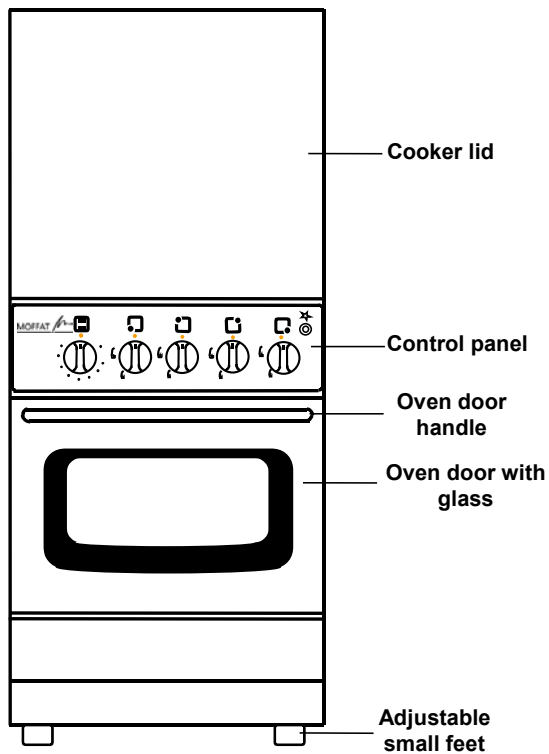

Hob

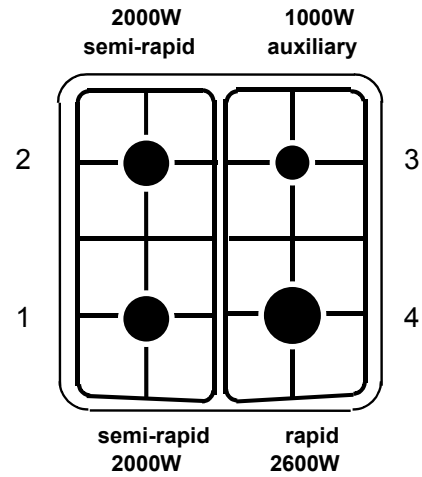

1. Front left burner (semi-rapid)
2. Back left burner (semi-rapid)
3. Back right burner (auxiliary)
4. Front right burner (rapid)

Control panel

Model : GSC 5062 W

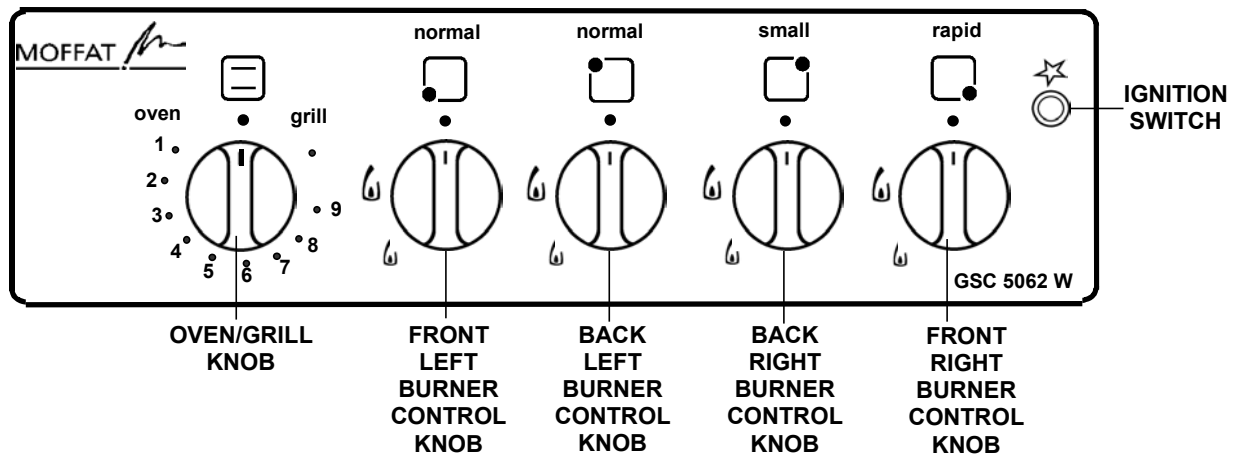

TECHNICAL FEATURES

Free standing

Class 1

Hob	Cooker lid	Enamelled	
	Pan support	Enamelled	
	Front right	Rapid	2,60kW
	Back right	Auxiliary	1,00kW
	Front left	Semi rapid	2,00kW
	Back left	Semi rapid	2,00kW
Oven	Oven	Gas	
	Oven power	3,20kW	
	Grill	Gas	
	Grill power	2,50kW	
Accessories	Oven grid	Chromed	
	Roasting tray	Enamelled	
	Roasting grid	Chromed	
	Grill Deflector	Enamelled	
Dimensions	Height with the lid closed	910 - 920 mm	
	Height to the hob	880 - 890 mm	
	Width	500 mm	
	Depth	600 mm	

 This appliance complies with the following EEC Directives :
89/336 (Electromagnetical Compatibility Directive) and subsequent modifications,
90/396 (Gas Appliance Directive)
93/68 (General Directives) and subsequent modifications.

USING THE APPLIANCE

Before the First Use of the Cooker

 **Remove all packaging both inside and outside of the cooker, before using it.**

Before first use, the oven should be heated without food. During this time, an unpleasant odour may be emitted. This is quite normal.

1. Remove the oven accessories and ensure all packaging has been removed.
2. Ignite the oven burner (see instructions) and turn the control knob to 9 (maximum).
3. Open a window for ventilation
4. Allow the oven to run empty for approximately 45 minutes.

This procedure should be repeated with the grill function for approximately 5-10 minutes.

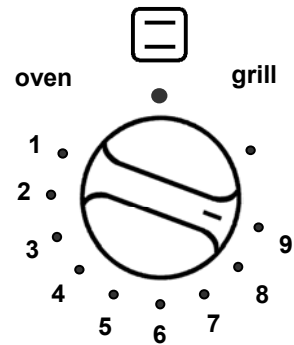

Using the Oven

 **The cooker gets hot when it is in use. Children should be kept away until it has cooled.**

Stand clear when opening the drop down oven door.

Do not allow it to fall open - support the door using the door handle, until it is fully open.

Attention: when turning on the oven and grill burner the oven door has to be opened.

The oven has three shelf levels, and is supplied with one shelf.

The shelf positions are counted from the bottom of the oven as shown in the diagram.

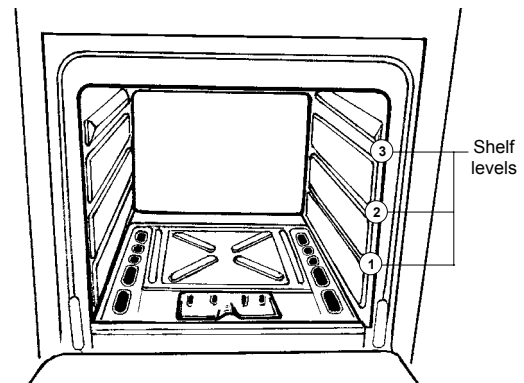

 **Do not place cookware or foil directly on the oven base.**

Oven Safety device

The cooker features a thermocouple; if for any reason the flame should extinguish, the device will stop the gas flow.

Use

The oven can be used for traditional cooking, or for grilling, but not both functions simultaneously. The symbol on the knob corresponds to the symbol on the control panel.

- Off
- “9” Maximum
- “1” Minimum
- “Grill” Grill function (heat come from the top burner only).

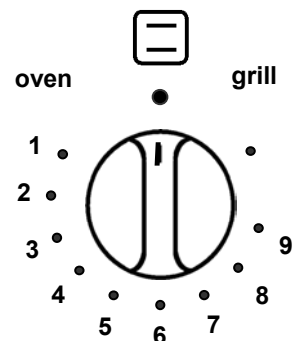

Ignition



Attention: when turning on the oven and grill burner the oven door has to be opened.

- **Open the oven door and lift the small lid on the bottom of the cavity**, push and turn the control knob to the left to position 9, **keeping the control knob pressed.**
- **At the same time, push the electronic ignition knob** (see fig). Keep it pushed until the gas ignites (1 spark / second).
- **Release the knob after 10 seconds** and check that the burner is ignited through the holes in the burner cover.

OR

Power Cut

- **Open the oven door** and lift the small lid on the bottom of the cavity, push and turn the control knob to the left to position 9, keeping the control knob pressed.
- **Release the knob after 10 seconds** and check that the burner is ignited through the holes in the burner cover.

If for any reason the flame should extinguish turn control knob to the off position, after at least 1 minute, try to re-ignite the oven.

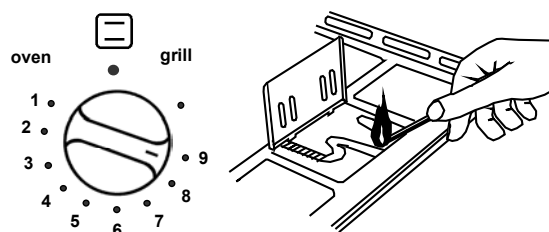
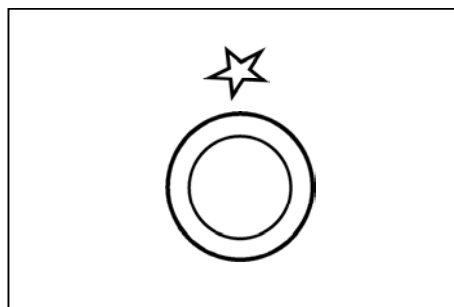

Cooking in the Oven

Traditional cooking is made by natural convection; the heated air circulates on the principle of ascending and descending draughts. It is necessary to pre-heat the oven.

All cookers vary and it is important to be aware of the approximate cooking temperatures before you use the cooker.

The chart shows the gas mark temperatures together with the approximate equivalent temperatures in °C.

It may be necessary to adjust the temperature to suit your individual requirements. Only experience will enable you to determine the correct setting for your personal requirements.

Gas Mark	Temperature °C
1	150
2	162
3	175
4	187
5	200
6	212
7	225
8	237
9	250

Hints and Tips

Condensation and steam

When food is heated it produces steam in the same way as a boiling kettle. The oven vents allow some of this steam to escape. However, **always stand back from the oven when opening the oven door** to allow any build up of steam or heat to release.

If the steam comes into contact with a cool surface on the outside of the oven, e.g. a trim, it will condense and produce water droplets. This is quite normal and is not a fault with the oven.

To prevent discolouration, regularly wipe away condensation and also soilage from surfaces.

Cookware

Use any ovenproof cookware, which will withstand temperatures of 250°C.

Oven dishes, etc. should not be placed directly on the oven base.

Oven Cooking

- Turn off the oven 5 minutes before the end of cooking time, and use residual heat to complete the cooking.
- The thickness, the material and the colour of the pan will influence the cooking results.
- When cooking, certain dishes increase in volume, ensure the pan is large enough.
- To prevent fat dripping when roasting use tall rim pans proportional to the item being roasted.
- Prick the skin of poultry and sausages with a fork before cooking to avoid spitting.
- Use heatproof glass dishes for soufflés.

The effects of dishes on cooking results

Dishes and tins vary in their thickness, conductivity, colour, etc. which affects the way they transmit heat to the food inside them.

- A** Aluminium, earthenware, oven glassware and bright shiny utensils reduce cooking and base browning.
- B** Enamelled cast iron, anodised aluminium, aluminium with non-stick interior and coloured exterior and dark, heavy utensils increase cooking and base browning.

Using the Grill

 **When using the grill it has to be supervised, the oven door opened and the grill deflector "A" in its place.**

Heat comes from the top of the oven. It is suitable for grilling meat (beef bacon, pork bacon ...) that remains tender, for toast or to brown food already cooked.

Grill burner ignition

 **Attention: when turning on the oven and grill burner the oven door has to be opened.**

- **Open the oven door** push and turn the control knob to the right to the "grill symbol" and **keeping the control knob pressed.**
- **At the same time, push the electronic ignition knob** (see fig). Keep it pushed until the gas ignites (1 spark / second).
- **Upon ignition, keep the knob pressed for approximately 10 seconds** (until the safety valve automatically keeps the grill burner lit).

OR

Power Cut

- Open the oven door.
- Hold a flame to the gas grill burner holes (see fig.).
- Press the oven/grill function control knob, then turn it to the "grill symbol". **Upon ignition, keep the knob pressed for approximately 10 seconds** (until the safety valve automatically keeps the grill burner lit).

If for any reason the flame should extinguish turn the control knob to the OFF position, leave for at least 1 minute and then re-ignite.

 **Accessible parts may become hot when the grill is in use. Children should be kept away.**

 **The grill pan will become hot during use, always use oven gloves when removing or replacing a hot grill pan.**

Grilling

 **When using the grill it has to be supervised, the oven door opened and the grill deflector "A" in its place.**

When grilling, only the top burner is heating. It is not necessary to preheat the grill.

1. Insert the food on the 2nd level.
2. Turn the knob to position "grill".
3. Adjust the grid and pan position to allow for different thicknesses of food. Position the food close the grill for faster cooking and further away for gentler cooking.

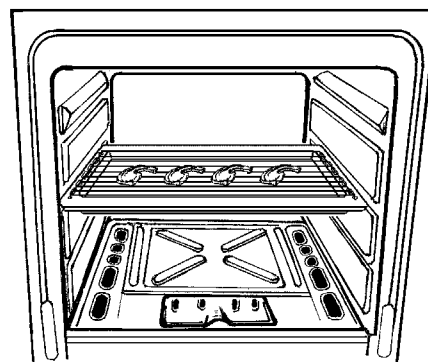
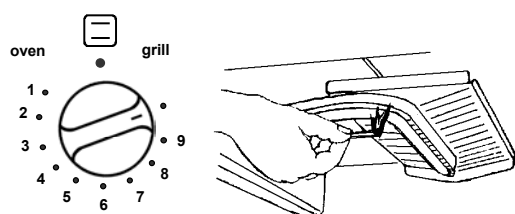
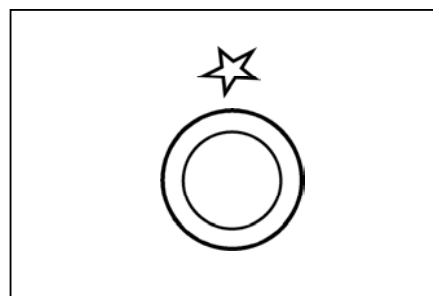
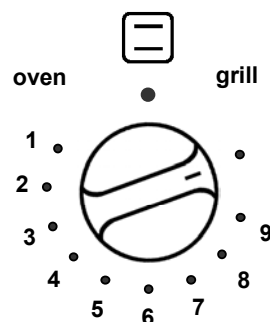
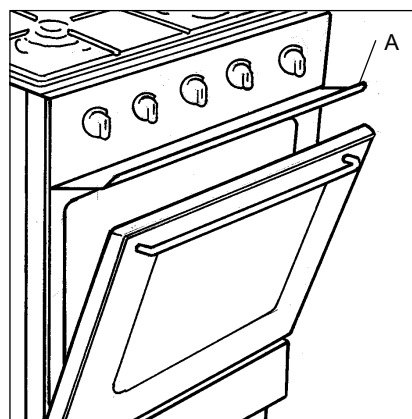

Heat comes from the top of the oven. It is suitable for grilling meat (beef bacon, pork bacon ...) that remains tender, for toast or to brown already cooked dishes.

Grilling meat

 **When using the grill it has to be supervised, the oven door opened and the grill deflector "A" in its place.**

 **Attention: when turning on the oven and grill burner the oven door has to be opened.**

- Prepare the meat to be grilled, lightly brush it with oil on both sides.
- Place it on the roasting grid.
- Turn the oven/grill control knob to position "grill".
- Slide the roasting grid together with the roasting tray in the guide 2.
- When the first side is brown, turn the meat without pricking it in order that the juices are not lost.
- Grill the second side.

Cooking time is determined by the thickness of the piece to be grilled not by its weight.

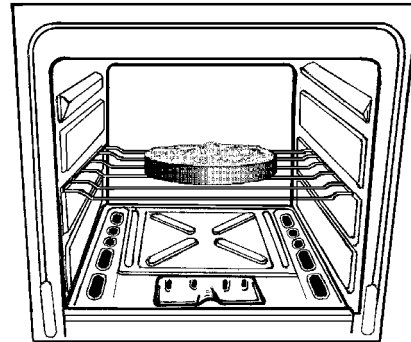



Browning

- Turn the oven/grill control knob to the "grill" position
- Place the dish on the grid and slide it on shelf guide 2 or 3.
- Leave the dish under the grill for a few minutes.

Using the Hob

The Hob Burners

The symbol on the knob corresponds to a symbol on the control panel (See description of appliance).

- Off
-  Maximum level
-  Minimum level

Use the maximum level for boiling and the minimum for simmering.

Always choose positions between the minimum and maximum, never between maximum and off.

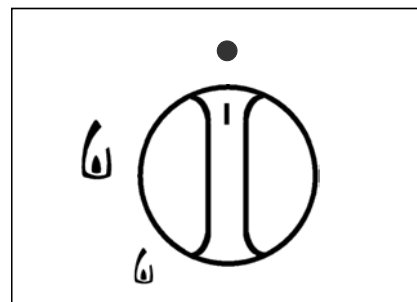

Ignition of the burners

- Push the knob and turn it left to the symbol "big flame".
- At the same time, push the electronic ignition knob (see fig). Keep it pushed until the gas ignites (1 spark / second).
- Release the knob and watch that the burner has ignited.
- Upon ignition, adjust the flame as required.

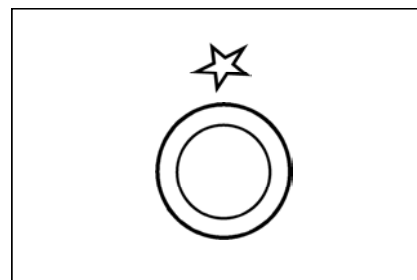

OR

Power Cut

- Push the corresponding knob in completely and turn it left to the symbol "large flame" symbol and ignite with a match.
- Release the knob and watch that the burner has ignited. Upon ignition, adjust the flame as required.
- If for any reason the flame should extinguish turn off the relevant control knob, leave for at least one minute and then re-ignite.



Extinguishing of burners

Turn the knob clockwise to mark « ● ».



Do not put anything on the hob that is liable to melt.

Selecting the Correct burner

Above every knob there is a symbol for the corresponding burner.

For good cooking results, always choose pans, which correctly fit to the diameter of the burner used (see figs). Choose thick, flat bottom pots.

We recommend the flame is lowered as soon as the liquid starts boiling.

For a correct ignition always keep the burner ring and the spark plugs clean.

The following diameter pans can be used:

Burner	Power (kW)	Diameter (mm)	
		min.	max.
Rapid	2,60	165	260
Semi-Rapid	2,00	140	220
Auxiliary	1,00	120	160

Good use

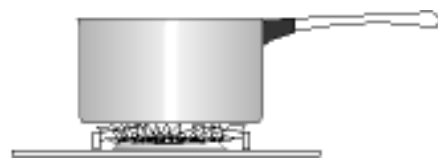

Bad use
(Power waste)



Accessories delivered with the appliance

The following accessories are supplied with your appliance.

- Grill Deflector
To be used when the grill is operation.
- Shelf for placing dishes on (roast, pastry mounds)
The dish should be put in the middle of the shelf to balance the weight.
- A roasting tray with roasting grid on it.
It is used to collect juice when cooking in it, place it on the shelf 2.
If you do not use the roasting tray, remove it from the oven.

In addition to the accessories supplied we recommend you only use heatproof dishes/pans (according to the manufacturer's instructions).

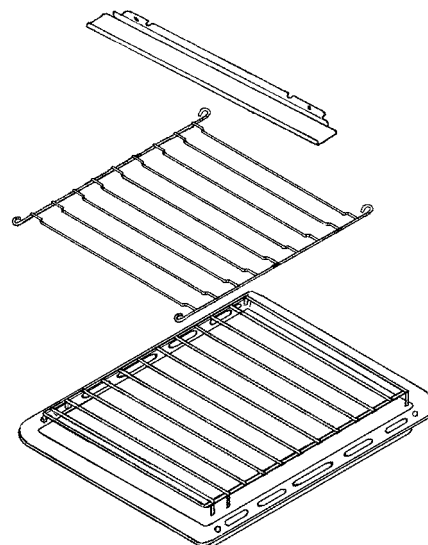

MAINTENANCE AND CLEANING

 **The oven should be kept clean at all times. A build-up of fats or other foodstuffs could result in a fire, especially in the grill pan.**

 **Before cleaning, ensure all control knobs are in the OFF position, and the appliance has cooled completely.**

 **Before any maintenance or cleaning can be carried out, you must DISCONNECT the cooker from the electricity supply.**

Cleaning materials

Before using any cleaning materials on your oven, check that they are suitable and that their use is recommended by the manufacturer.

 **Cleaners that contain bleach should NOT be used as they may dull the surface finishes. Harsh abrasives should also be avoided.**

External cleaning

Regularly wipe over the control panel, oven door and door seal using a soft cloth well wrung out in warm water to which a little washing up liquid has been added.

 **To prevent damaging or weakening the door glass panels avoid the use of the following:**

- Household detergent and bleaches
- Impregnated pads unsuitable for non stick saucepans
- Brillo/Ajax pads or steel wool pads
- Chemical oven pads or aerosols
- Rust removers
- Bath/Sink stain removers

Oven Cavity

The enamelled oven cavity is best cleaned whilst the oven is still warm.

Wipe the oven over with a soft cloth soaked in warm soapy water after each use. From time to time it will be necessary to do a more thorough cleaning, using a proprietary oven cleaner.

Oven Door Glass

The internal oven door glass can be removed for cleaning. For this purpose remove the 2 fixing screws. Clean the outer and inner door glass using warm soapy water. Should the inner door glass become heavily soiled it is recommended that a cleaning product such as Hob Brite, or Bar Keepers Friend be used.

Always support the door while removing the glass panel as the door may spring closed due to its lighter weight.

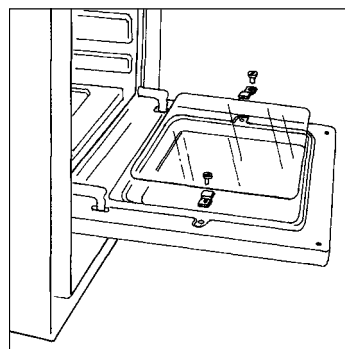

Removing the Oven Door

1. Open the door completely.
2. Turn the two locking levers (1) on the hinge arms fully upwards.
3. Hold the oven door at the sides using both hands and close the door partially to a 30° angle.
4. Lift the door and pull out.

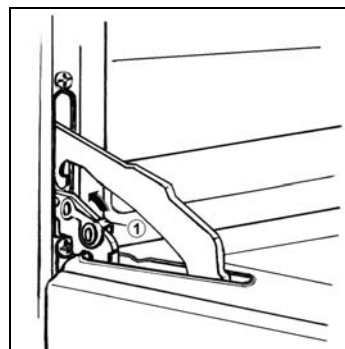

Hanging the Oven Door

1. Hold the oven door at the sides using both hands and hold the door at an angle of approx 30°.
2. Introduce and then push the hinges into the cut-outs on the front of the oven, ensuring that the supports (2) of the hinge arms are correctly placed in the cut-outs (3) of the hinge support.
3. Turn the locking levers (1) fully downwards.

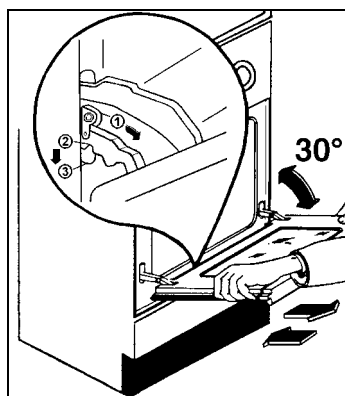

⚠ DO NOT clean the oven door while the glass panels are warm. If this precaution is not observed the glass panel may shatter. If the door glass panel becomes chipped or has deep scratches, the glass will be weakened and must be replaced to prevent the possibility of the panel shattering. Contact your local Service Centre who will be pleased to advise further.

IMPORTANT: The inner door glass must be in place when using the oven.

Hob

After every use wipe with a soft cloth well wrung out in warm water to which a little washing up liquid has been added, avoiding any leakage through the holes of the hob. Rinse and dry with a soft cloth.

To remove more stubborn stains, wet and leave to dissolve, do not scratch and avoid the use of abrasive or caustic products that could damage the enamel.

Burners

The burner caps and crowns can be removed for cleaning.

Wash the burners caps and crowns using hot soapy water, and remove marks with a mild paste cleaner. A well-moistened soap impregnated steel wool pad can be used with caution, if the marks are particularly difficult to remove.

After cleaning, be sure to wipe dry with a soft cloth.

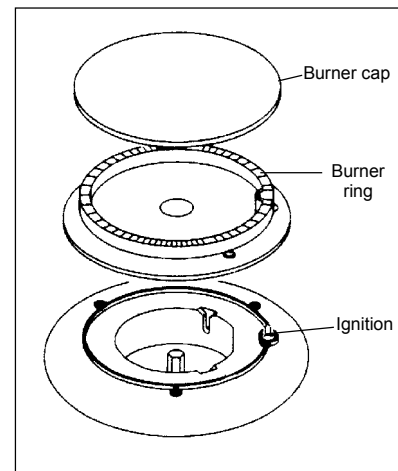

SOMETHING NOT WORKING

If the appliance is not working correctly, please carry out the following checks, before contacting your local Service Force Service Centre.

IMPORTANT: If you call out an engineer to a fault listed below, or to repair a fault caused by incorrect use or installation, a charge will be made even if the appliance is under guarantee.

Symptoms	Solutions
1. No burner ignition	<p>Check that:</p> <ul style="list-style-type: none"> • Gas supply is completely open • The position of gas pipe is correct • The burner is not wet • The burner cap and ring burner have been replaced correctly after cleaning
2. The gas ring burns unevenly	<p>Check that:</p> <ul style="list-style-type: none"> • The main jet is not blocked and the ring burner is clean of food particles • The burner cap and ring burner have been replaced correctly after cleaning
3. One of the oven or grill burners does not ignite	<p>Check that:</p> <ul style="list-style-type: none"> • The burner is in its correct place • The burner is not wet • The control knob has been pressed for 10 seconds upon ignition
4. Cooking results are not satisfactory	<p>Check that:</p> <ul style="list-style-type: none"> • The correct temperature has been selected • The cooking time is adapted • The grill is placed correctly in the oven
5. The oven smokes	<p>Check that:</p> <ul style="list-style-type: none"> • The oven does not need cleaning • The food does not spill over • There is no excessive fat / juice on the oven sides • Check the fuses.

If after these checks, the appliance still does not operate correctly, contact your local Service Force Centre. When you contact the Service Force Centre you will need to give the following details:

1. Your name, address and post code.
2. Your telephone number
3. Clear and concise details of the fault
4. The model and serial number of the appliance (found on the rating plate*)
5. The purchase date

* The rating plate can be found on the lower left hand corner of the front frame of the cavity.

Please note that a valid purchase receipt or guarantee documentation is required for in-guarantee service calls.

SERVICE AND SPARE PARTS



In the event of your appliance requiring service, or if you wish to purchase spare parts, please contact your local Service Force Centre by telephoning:-

08705 929929

Your telephone call will be automatically routed to the Service Force Centre covering your post code area.

For the address of your local Service Force Centre and further information about Service Force, please visit the website at www.serviceforce.co.uk

Before calling out an engineer, please ensure you have read the details under the heading "Something Not Working" and have the model number and purchase date to hand.

In-guarantee customers should ensure that the checks under the heading "Something Not Working" have been made as the engineer will make a charge if the fault is not a mechanical or electrical breakdown. Please note that it will be necessary to provide proof of purchase for any in-guarantee service calls.

CUSTOMER CARE

For general enquiries concerning your Moffat appliance and or for further information on our products, contact our Customer Care Department by letter or telephone as follows:

Customer Care Department
Moffat
55-77 High Street
Slough
Berkshire SL1 1DZ

Tel: 08705 950 950 (*)

(*) Calls may be recorded for training purposes.

GUARANTEE CONDITIONS

Standard Guarantee Conditions

We Moffat undertake that if, within 12 months of the date of the purchase, this Moffat appliance or any part thereof is proved to be defective by any reason only of faulty workmanship or materials, we will, at our option, repair or replace the same FREE OF ANY CHARGE for labour, materials or carriage on condition that:

- The appliance has been correctly installed and used only on the electricity supply stated on the rating plate.
- The appliance has been used for normal domestic purposes only, and in accordance with the manufacturer's instructions.
- The appliance has not been serviced maintained, repaired, taken apart or tampered with by any person not authorised by us.
- All service work under this guarantee must be undertaken by a Service Force Centre.
- Any appliance or defective part replaced shall become the Company's property.
- This guarantee is in addition to your statutory and other legal rights.

Home visits are made between **8.30am and 5.30pm** Monday to Friday. Visits may be available outside these hours, in which case a **premium** will be charged.

Exclusions

This guarantee does not cover:

- Damage or calls resulting from transportation, improper use or neglect, the replacement of any light bulbs or removable parts of glass or plastic.
- Costs incurred for calls to put right an appliance which is improperly installed or calls to appliance outside the United Kingdom.
- Appliances found to be in use within a commercial or similar environment, plus those, which are the subject to rental agreements.
- Products of Moffat manufacture which are not marketed by Moffat.

European Guarantee

If you should move to another country within Europe then your guarantee moves with you to your new home subject to the following qualifications:

- The guarantee starts from the date you first purchased your product.
- The guarantee is for the same period and to the same extent for labour and parts as exist in the new country of use for this brand or range of products.
- This guarantee relates to you and cannot be transferred to another user.
- Your new home is within the European Community (EC) or European Free Trade Area.
- The product is installed and used in accordance with our instructions and is only used domestically, i.e. a normal household
- The electrical supply complies with the specification given in the rating label.
- The product is installed taking into account regulations in your new country.

Before you move, please contact your nearest Customer Care Centre, listed below, to give them details of your new home. They will then ensure that the local Service Organisation is aware of your move and able to look after you and your appliances.

France	Senlis	+33 (0) 3 44 62 20 13
Germany	Nürnberg	+49 (0) 800 234 7378
Italy	Pordenone	+39 (0) 800117511
Sweden	Stockholm	+46 (0) 20 78 77 50
UK	Slough	+44 (0) 1753 219898

INSTRUCTIONS FOR THE INSTALLER



SAFETY ADVICE

- Before installation ensure that the local distribution conditions (gas type and pressure) and the pre-setting of the appliance are consistent.
- This appliance must be installed only in a room with good ventilation.
- This appliance must not be connected to a flu. It has to be installed and connected in accordance with the rules in force. Special attention should be paid to the applicable disposal concerning ventilation.
- The adjacent furniture panels have to be heat proof or protected by such material.
- The adjusting conditions of this appliance are mentioned on the rating plate.

Connection to gas supply.

Check that the gas flow and the diameter of the supply pipe is sufficient to supply all the appliances of the installation.

- Check that all connections are tight.
- Install an accessible and visible gas tap to isolate the appliance.

ELECTRIC CONNECTION



Any electrical work required to install this cooker should be carried out by a qualified electrician or competent person, in accordance with the current regulations.



This cooker must be earthed.

This cooker is designed to be connected to a 240V 50Hz AC electrical supply.

Before switching on, make sure the electricity supply voltage is the same as that indicated on the rating plate.

Check on the rating plate the value for the total connection power for establishing the fuse power.

Fuse capacity: 5 A



If the supply cable is damaged it must be replaced by the manufacturer or its service agent.

Before connecting check that:

- The plug used for connection is easily accessible when the appliance is installed.

- Installation of flues and ventilation for gas appliances of rated input not exceeding 60 kW (1st, 2nd and 3rd family gases) – Part 2 Specification for installation of ventilation for gas appliances – BS 5440;
 - Gas burning appliances – Part 3 Domestic cooking appliances burning gas – BS 5386;
 - Specification for installation of low pressure gas pipe work of up to 20mm (R1) in domestic premises (2nd family gas) – BS 6891;
 - Pipe threads for tubes and fittings where pressure-tight joints are made on the threads (metric dimensions) – BS 21: 1985;
 - Flexible hoses, end fittings and sockets for gas burning appliances – BS 669;
- Installation of domestic gas cooking appliances (1st, 2nd and 3rd family gases) – BS 6172: 1990;**

Warning



The supply cable must not be routed across the back of the oven.

YES

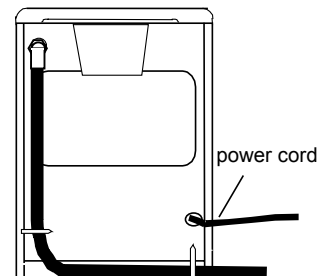

NO

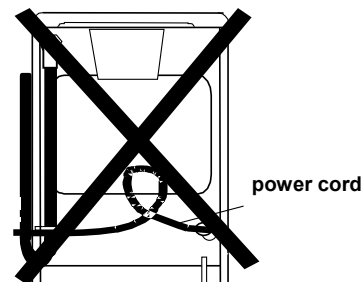

TECHNICAL DATA

Table no.1
(Cat : II 2H3+)

Burner	Normal power (kW)	Economic power (kW)	By-pass (mm)	Gas Type	Pressure (mbar)	Nozzle diameter (mm)	Cons	
							m ³ /h	g/h
RAPID	2.60	0.72	0.42	Natural Gas	20 mbar	1.12	0.248	188,8
				Butane	28-30mbar	0,86		
				Propane	37mbar	0,86		
SEMI-RAPID	2.00	0.43	0.32	Natural Gas	20 mbar	0.96	0.191	145,2
				Butane	28-30mbar	0,71		
				Propane	37mbar	0,71		
AUXILIARY	1.00	0.35	0.29	Natural Gas	20 mbar	0.70	0.093	72,6
				Butane	28-30mbar	0,50		
				Propane	37mbar	0,50		
OVEN	3.20	1.00	0.46	Natural Gas	20 mbar	1.30	0.305	232,4
				Butane	28-30mbar	0,88		
				Propane	37mbar	0,88		
GRILL	2.50	-	-	Natural Gas	20 mbar	1,15	0,238	181,5
				Butane	28-30mbar	0,80		
				Propane	37mbar	0,80		

INSTALLATION

Positioning

Remove all the packaging and install the cooker in a dry, ventilated room not near curtains, paper, alcohol, petrol etc. (See figure).

This appliance is approved to class "1" regarding overheating of surrounding surfaces.

It is mandatory to keep 20mm distance to the adjacent furniture.

 **L.P.G. cookers or ovens MUST NOT be installed below ground level, i.e. in a basement, or aboard any boat, yacht or other vessel.**

 **The cooking appliance must be fitted with a stability chain firmly secured to the wall (see fig)**

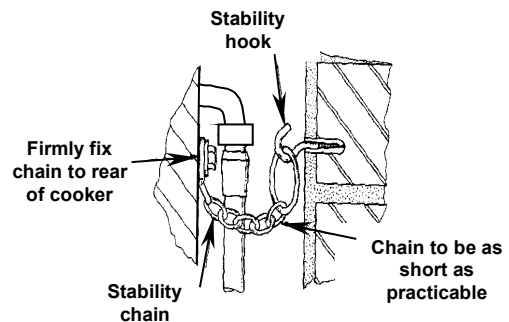
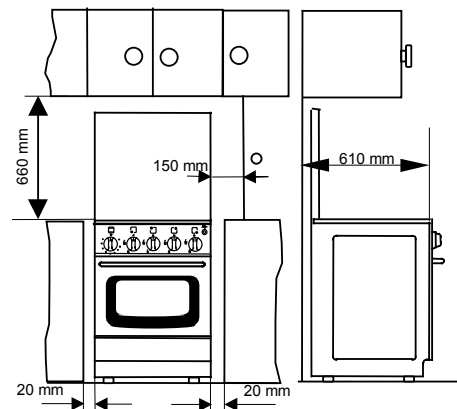

Ventilation

The room containing the cooker should have an air supply in accordance with B.S. 5440: Part 2: Current Editions.

The following requirements for ventilation must be met.

The cooker should not be installed in a bed sitting room with a volume of less than 20m³, if it is installed in a room of volume less than 5m³ an air vent of effective area of 110cm² is required; if it is installed in a room of volume between 5m³ and 10m³, an air vent of effective area 50cm² is required, while if the volume exceeds 11m³ no air vent is required. However, if the room has a door, which opens directly to the outside, no air vent is required even when the volume is between 5m³ and 11m³.

If there are other fuel burning appliances in the same room, B.S. 5440: Part. 2: Current Editions should be consulted to determine the requisite air vent requirements.

Location

The cooker may be located in a kitchen, a kitchen/diner or bed sitting room but not in a bathroom, shower room or garage.

For information regarding the fitting of flexible supply pipes, the highest temperature at the rear of this cooker which may come into contact with the supply pipe is 70°C above ambient.

When the appliance has been installed there must be enough space for the hotplate lid (when present) to open fully.

 **L.P.G. cookers or ovens MUST NOT be installed below ground level, i.e. in a basement, or aboard any boat, yacht or other vessel.**

Levelling

Fix the support with two legs with the washer and nuts, delivered with the cooker, see the figure.

- Unscrew the legs as far as possible (approx. 16mm from fully screwed in).
- Place the plinth (pos.3) so that the springs (pos.2) reach the threaded area of the legs and the clamp of the plinth (pos.4) is in front of the holes (pos.5) on the under side of the structure.
- Push the plinth towards the appliance with both hands until the springs fasten on the legs and the clamps go into the corresponding holes.
- Adjust the legs as necessary.

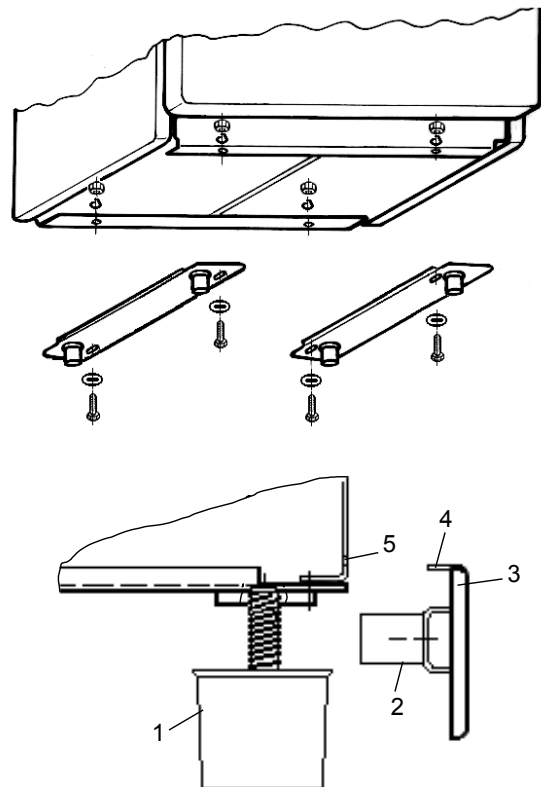



GAS CONNECTIONS

Your cooker is delivered adjusted for the kind of gas stated on the rating plate

If the appliance is supplied with natural gas and the pressure for natural gas is 20mbar. The following methods of connection to the gas supply must be used:

Right Hand Connection (from front)

Ensure that the rubber hose is not in contact with any part of the hatched area shown in the diagram and that the loop of the hose when connected is not in contact with the floor when the appliance is in position.

BACK OF THE COOKER

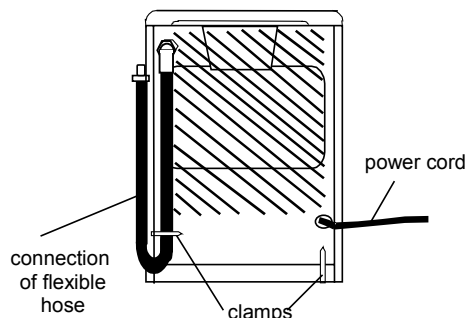

BACK OF THE COOKER

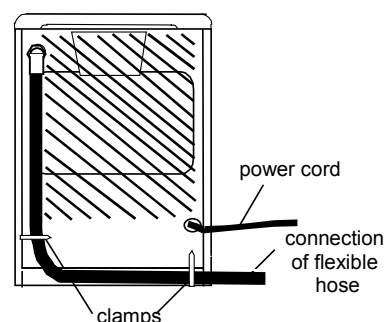

Left Hand Connection (from front)

Ensure that the rubber hose is not in contact with any part of the hatched area shown in the diagram and the hose is retained in the clamp provided, it will be necessary to fit the maximum length hose when using this method.

Fixing and use of the 2 clips provided with the cooker

The enclosed gas hose fixing clips must be fixed to the back of the cooker, dependant on the position of the supply bayonet connector (see fig.).

When selecting the most suitable position for the clips, please ensure that the gas hose cannot come into contact with any part of the "Hot" zone when pushing the cooker into its final position.

Finally, secure the hose into the clips.

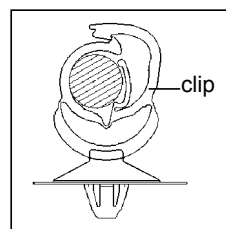

Clip Position Options

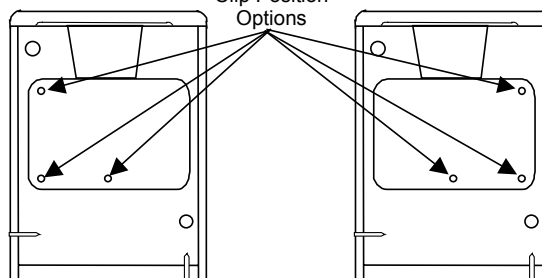

Rigid Connection

Where it is not possible to make the connection using a rubber hose, a rigid pipe work connection must be used.

Recommendations when using an appliance flexible connector are as follows:

- For NATURAL the gas installation pipes to the termination point shall comply with:

Specification for installation of low-pressure gas pipe work of up to 20mm (R1) in domestic premises (2nd family gas) – BS 6891;

Connection shall be by means of an appliance flexible connector for use with a self-sealing plug-in device, complying with:

Flexible hoses, end fittings and sockets for gas burning appliances – BS 669;

- The appliance flexible connector should not be subjected to undue forces either in normal use or whilst connected or disconnected; The socket which the plug of the appliance flexible connector fits should be permanently attached to a firmly fixed gas installation pipe and positioned such that the appliance flexible connector hose hangs freely downwards (see fig. 27);
- The appliance flexible connector should be positioned such that it will not suffer mechanical damage, e.g. abrasion from the surrounding kitchen furniture, which may be moved in use such as a drawer or door, or by being trapped by any stability device.

The plug-in-connector should be accessible for disconnection after moving the appliance.

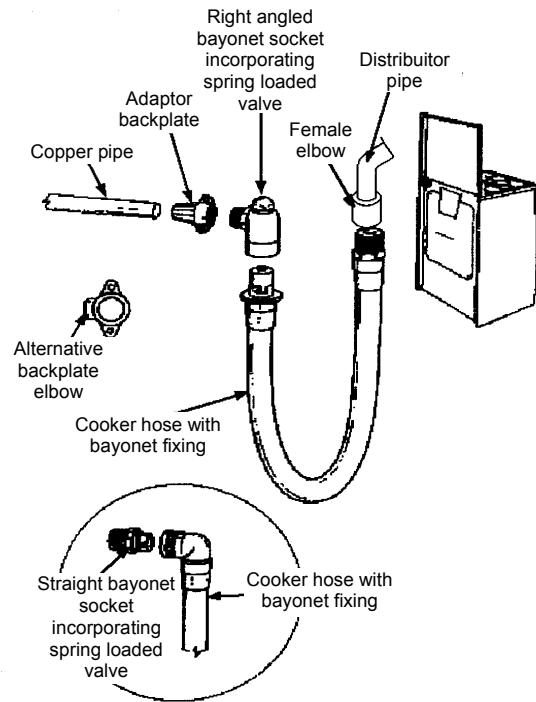

CONVERSION OF GAS

Your cooker is designed to work with natural gas, and is convertible for use with propane or butane.

The LPG conversion kit is available from your Service Force Centre and must be fitted by a Corgi Registered engineer.

For changing the gas type it is necessary to:

- replace the nozzles (hob, oven and grill);
- adjust the minimum level (hob and oven);
- adjust the primary air (oven and grill);
- check the gas connection;



Stick the label supplied with the appliance (in the nozzles bag) corresponding to the gas type utilised.

Replace the nozzles of the hob burners

Every appliance has spare nozzles for every type of gas. The whole length of every nozzle is marked in millimetres on the nozzle.



Hob burners

- Remove the pan support;
- Remove the caps and the burner crowns;
- Using a No 7 socket spanner unscrew the nozzles and replace them with those required for the type of gas in use (see table no. 1).

Reassemble the parts following the same procedure in reverse.

These burners do not need any primary air regulation.

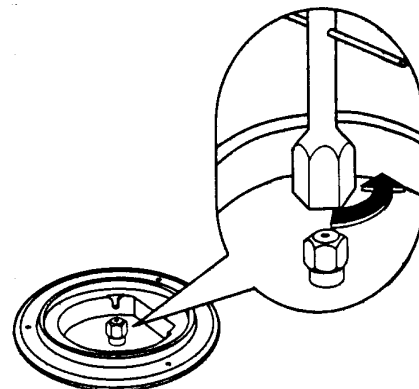

Adjustment of minimum level for the hob burners

The burner is correctly adjusted when the flame is stable silent and goes out without any noise.

When changing the type of gas check that the minimum level is correct. The air admission is correct when the flame is about 4 mm in length.

The top burners do not need adjustment of primary air.

Check that, turning the knob quickly from the maximum position to the minimum one, the flame does not go out.

Hob burners

To adjust the minimum level:

- Light the burner
- Turn the knob to the position of the minimum flame;
- Remove the knob;
- Unscrew or screw the by-pass screw (on the right above of tap shaft) until a regular small flame is reached.
- For LPG screw completely the by-pass screw.

Reassemble the parts following the same procedure in reverse.

Check that, when turning the knob quickly from the maximum position to the minimum one, the flame does not go out.

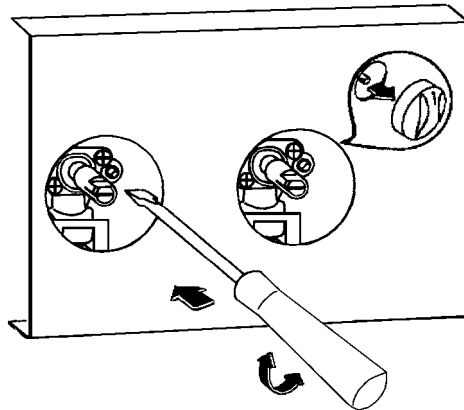

Replace the nozzles of the oven burners

Oven burner

To replace the gas oven nozzle, follow this procedure:

- Check the table no.1 for diameter of nozzle;
- Remove the oven removable base panel;
- Remove the screw on the oven burner rod at the rear of the oven;
- Remove the oven burner by pushing it backwards.
- Replace the nozzle by means of a No 10 socket spanner;

Reassemble the parts following the same procedure in reverse.

Grill burner

To replace the gas grill nozzle, follow this procedure:

- Remove the grill burner after removing the fixing screw.
- Replace the nozzle by means of a No 10 socket spanner;
- Refit all parts and test.

Flame adjustment

Oven burners

The burner is correctly adjusted when the flame is stable, silent and goes out without any noise.

- When the flames are too short, the nozzle is whistling or the flames have the tendency to detach from the burner, it means that there is too much air in the valve. If there is too much air there is a risk that the flames will extinguish.
- But, if the flames are too long, soft, lighting, there is not enough air in the valves. These flames discolour the bottom of pans.
- Loosen the screw M which fixing the air adjuster A;
- Move the air adjuster A forward or backward until achieving the right mixture (see table no. 2);
- Tighten the fixing screw M.

Grill burner

- Loosen the screw fixing the Venturi.
- Move the adjusting collar left or right until achieving the correct flame picture (see table no. 2).
- Tighten the fixing screw.

Adjustment of minimum level

Oven burner

- Remove the top pan support as well as the burner caps and the burner crowns.
 - Unscrew and remove the 2 top plate fixing screws and remove the top plate.
 - Light the burner knob on position 9 and leave the oven door closed for about 10 min.
 - Turn the knob slowly to position 1.
 - Pull off the knob to adjust minimum flow.
 - Unscrew or screw the by-pass screw (is it above of tap shaft) until a regular small flame is reached.
 - For LPG screw completely the by-pass screw.
- The flame shouldn't extinguish when closing the oven door.

Grill burner

The grill temperature cannot be adjusted. To obtain a lower temperature or slower cooking time the grill pan must be lowered away from the flame.

 **AFTER COMPLETION OF ANY REPAIRS, ADJUSTMENTS OR CONVERSION THE STATUTORY SAFETY TESTS MUST BE CARRIED OUT.**

Table no.2

Gas type	Air adjusting (mm)	
	Oven	Grill
G20	2,5	25,5
G30	3,5	24
G31	3,5	24

